

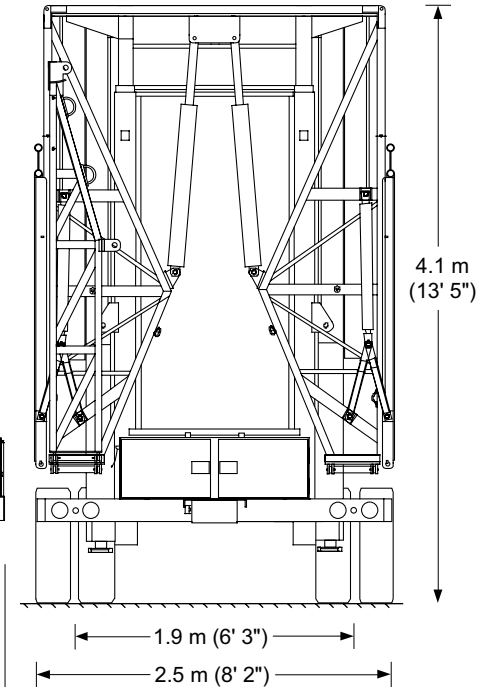

700 Marsolais Street
 L'Assomption, Quebec
 Canada J5W 2G9
 Tel: (450) 589-1063
 or 1-800-267-8243
 Fax: (450) 589-1711
 www.stageline.com
 info@stageline.com

Stageline SL 320

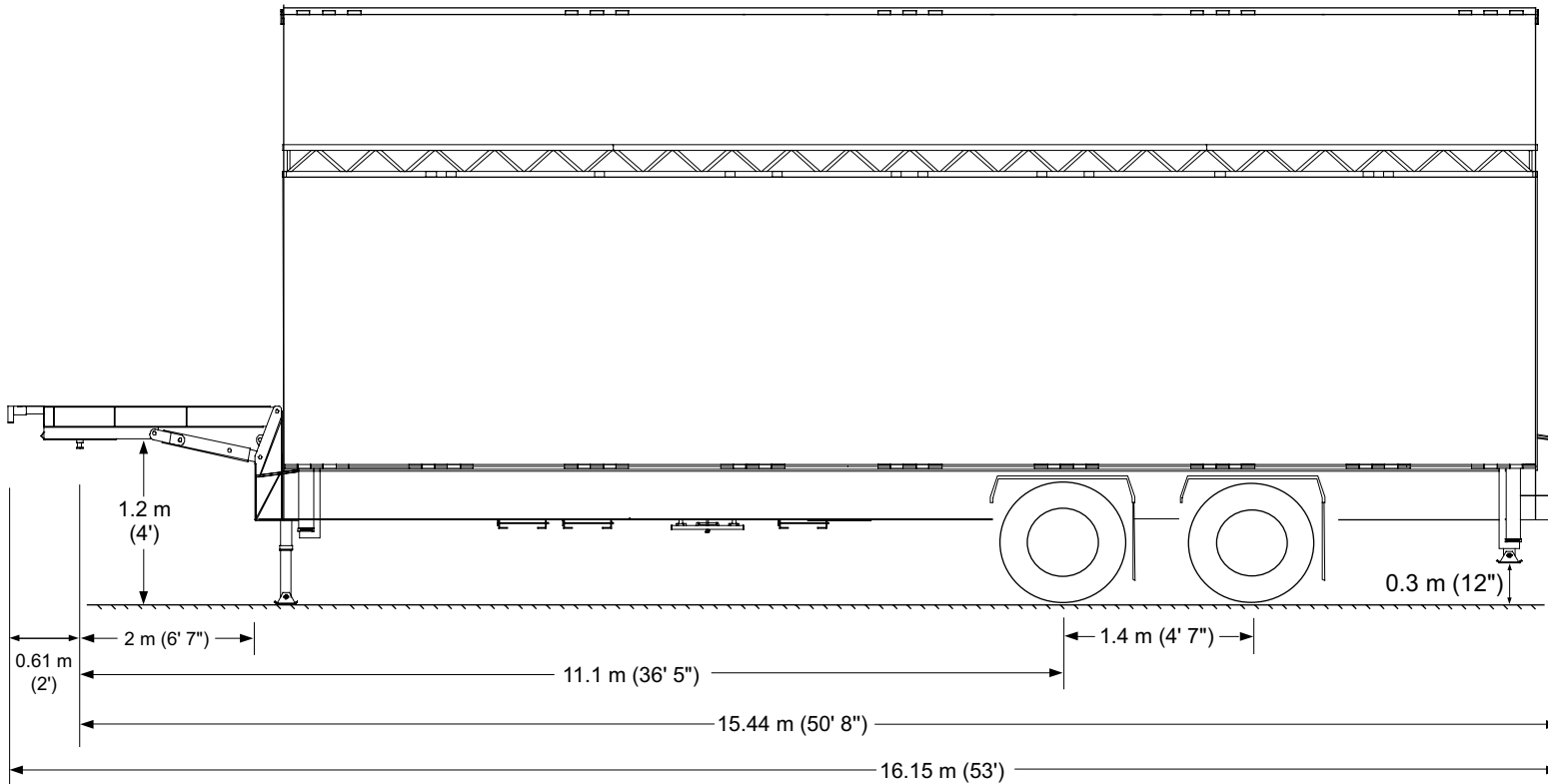

	Kg	Lbs
Gross Weight (Unladen)	19100	42100
Gross Weight (Laden)	21360	47100
Weight on axles (Laden)	15420	34000
Weight on Gooseneck (Laden)	5940	13100

Mass & Dimensions

1. Mass may vary depending on options.
2. Technical specifications may change without notice.
3. Drawings are not to scale.

© 2005 - All rights reserved, Stageline® Mobile Stage Inc. Any and all forms of adaptation or reproduction of this document including plans and drawings found herein, in whole or in part, are strictly forbidden without the written authorisation of Stageline® Mobile Stage Inc.

Date: 2005-06-28
 Ref. No.: S09-V-003-A
 Revision 5



700 Marsolais Street
L'Assomption, Quebec
Canada J5W 2G9
Tel: (450) 589-1063
or 1-800-267-8243
Fax: (450) 589-1711
www.stageline.com
info@stageline.com

Stageline SL 320

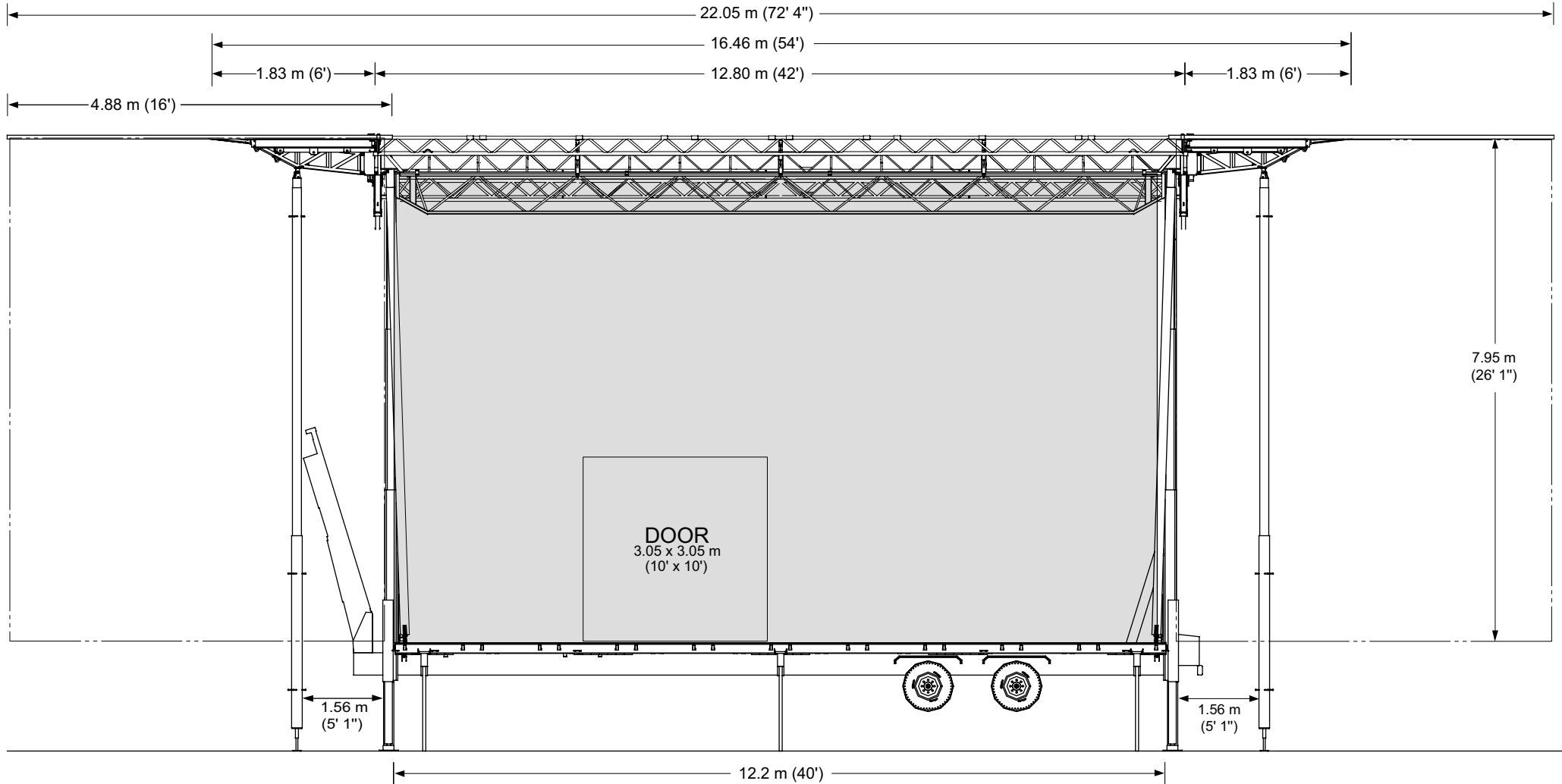

Front View with Windwall and Banners



700 Marsolais Street
L'Assomption, Quebec
Canada J5W 2G9
Tel: (450) 589-1063
or 1-800-267-8243
Fax: (450) 589-1711
www.stageline.com
info@stageline.com

Stageline SL 320

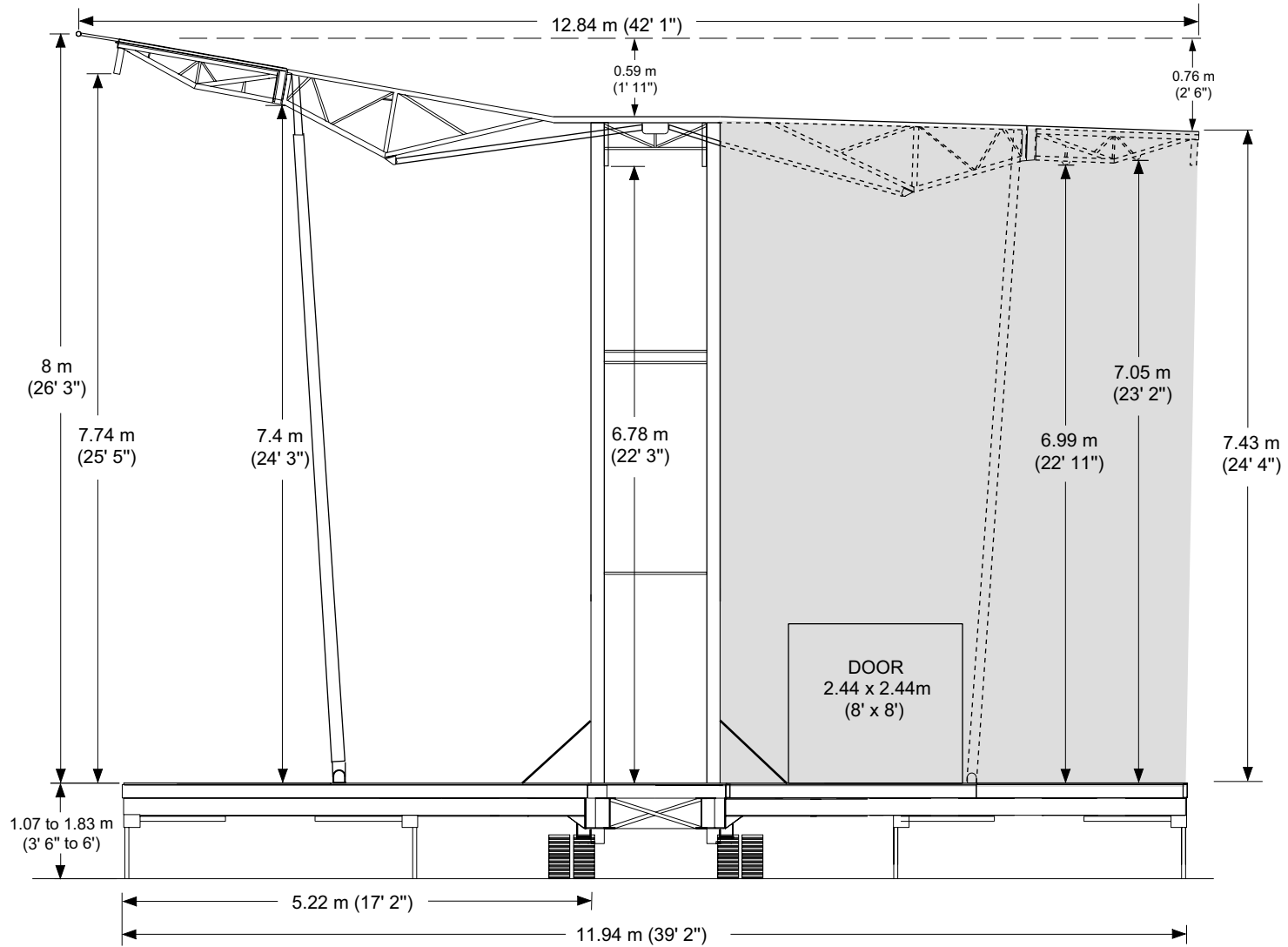

Side View with Banners and Windwall



700 Marsolais Street
L'Assomption, Quebec
Canada J5W 2G9
Tel: (450) 589-1063
or 1-800-267-8243
Fax: (450) 589-1711
www.stageline.com
info@stageline.com

Stageline SL 320

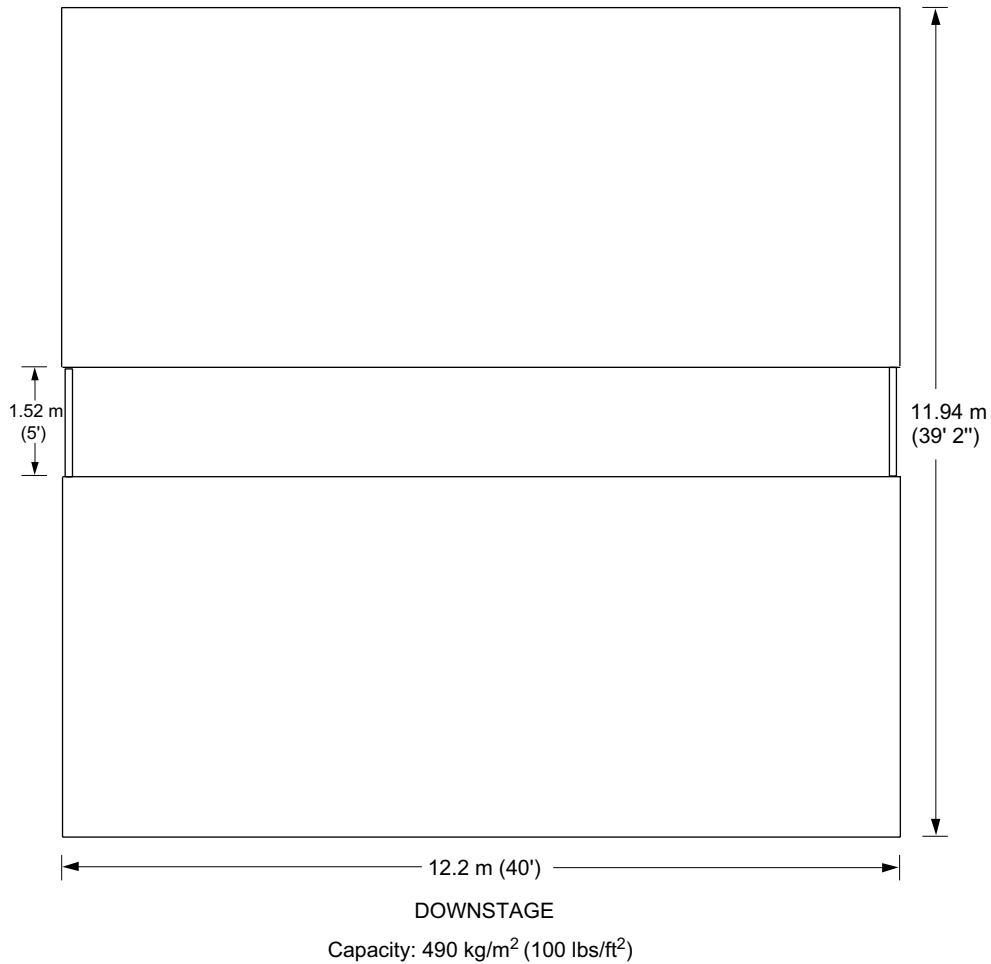

Floor View



700 Marsolais Street
L'Assomption, Quebec
Canada J5W 2G9
Tel: (450) 589-1063
or 1-800-267-8243
Fax: (450) 589-1711
www.stageline.com
info@stageline.com

Stageline SL 320

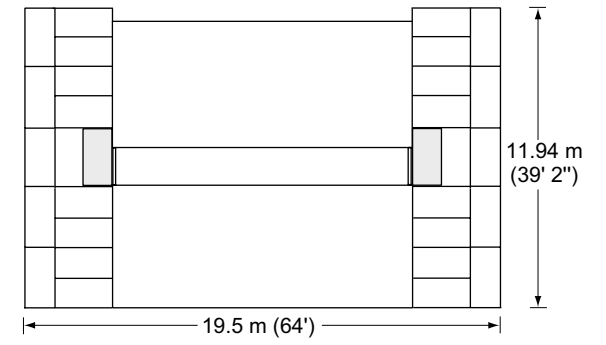
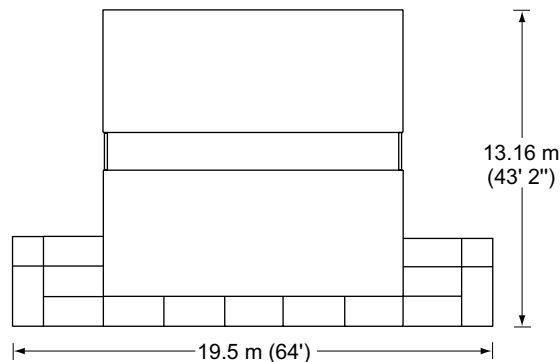
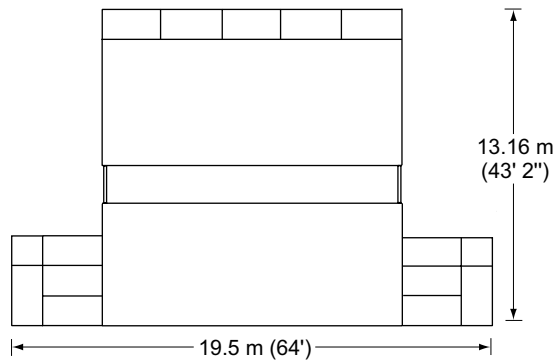
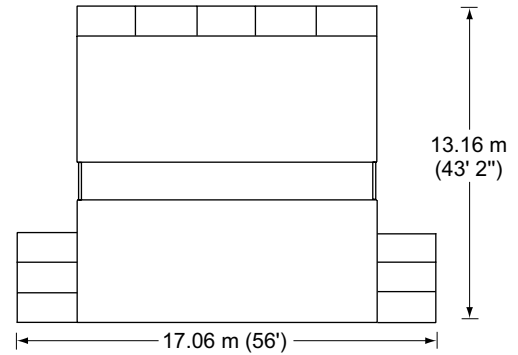
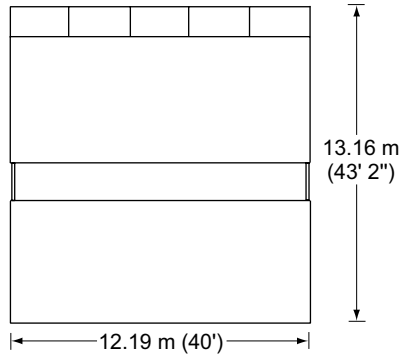

Floor Extension Layouts



700 Marsolais Street
L'Assomption, Quebec
Canada J5W 2G9
Tel: (450) 589-1063
or 1-800-267-8243
Fax: (450) 589-1711
www.stageline.com
info@stageline.com

Stageline SL 320

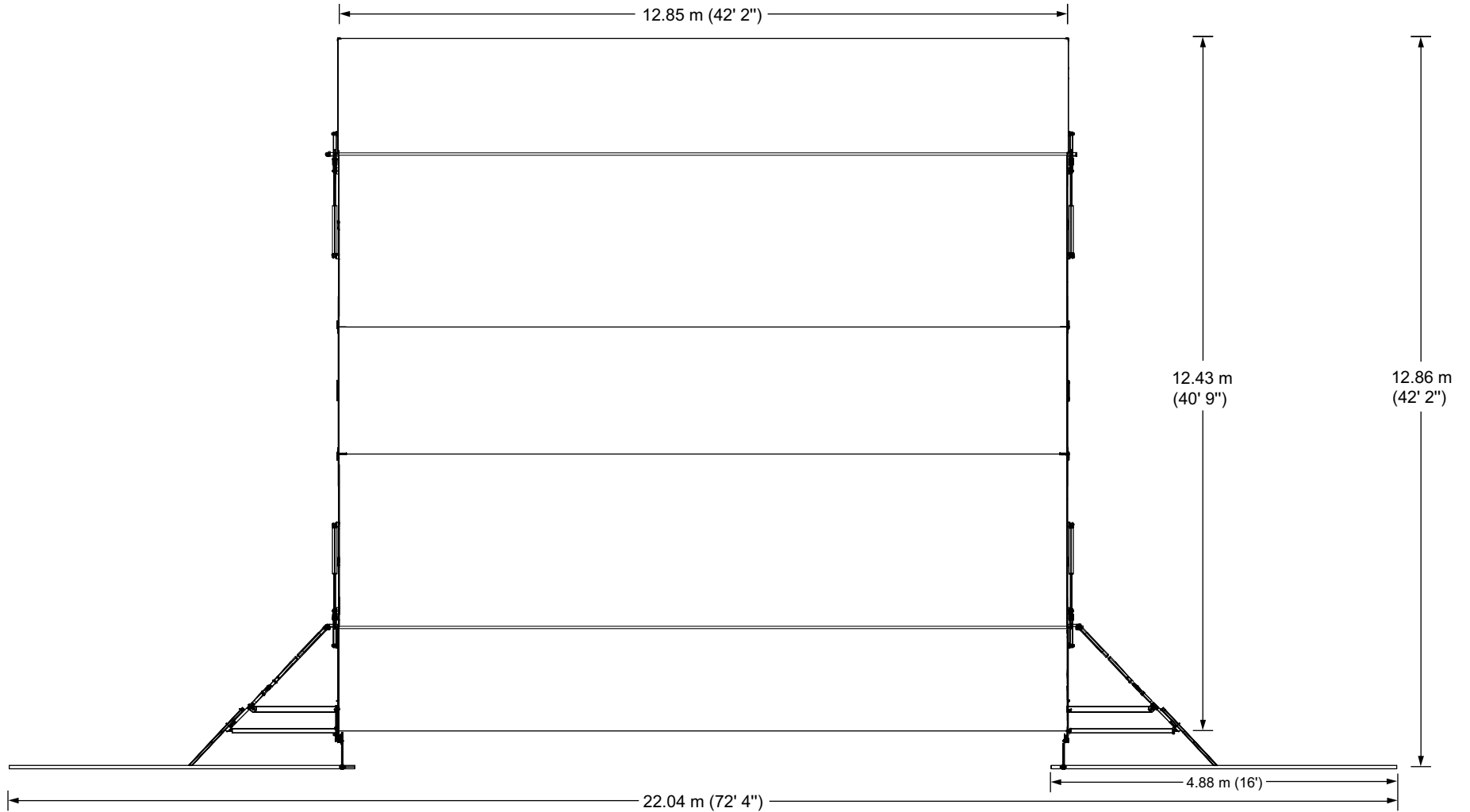

Roof View with Banners



700 Marsolais Street
L'Assomption, Quebec
Canada J5W 2G9
Tel: (450) 589-1063
or 1-800-267-8243
Fax: (450) 589-1711
www.stageline.com
info@stageline.com

Stageline SL 320

A thorough understanding of the inter-related loadings shown in this rigging plan is needed in order to safely use this mobile stage roof and to take full advantage of the many rigging opportunities it offers.

This mobile stage roof offers a variety of rigging options with regard to load capacity, placement and type.

There are trusses, rigging pipes, front overhang rigging pipes, side overhang rigging beams, line array rigging beams and roof rigging points.

This rigging plan locates and defines these rigging features, includes load capacity for each and describes maximum combinations of loads amongst features.

Take note of exclusions, maximum sub-totals in a group, load balance requirements, maximum lifting capacity of roof and maximum rigging load on roof.

The maximum load on the roof is less than the sum of the maximum load on each rigging feature.

RIGGING RESTRICTIONS

Use both P1s, P2s, P3s, P4s or P5 alone.

Use both P6s, P7s, P8s or P9 alone.

Do not load P11s concurrently with truss T2

Do not load more than 454 kg (1000 lbs) on each twin set of P10 in upstage roof panel.

Do not load more than 227 kg (500 lbs) on each twin set of P11.

Rigging Point Maximum Load Capacity		
Point No.	Kg	Lbs
P12	908	2000
P1 & P2	680	1500
P3	544	1200
P6 & P10	454	1000
P4 & P5	318	700
P7	295	650
P11	227	500
P8 & P9	182	400

Notes:

Outside diameter of rigging bars and of lower chord of trusses is 5 cm (2").

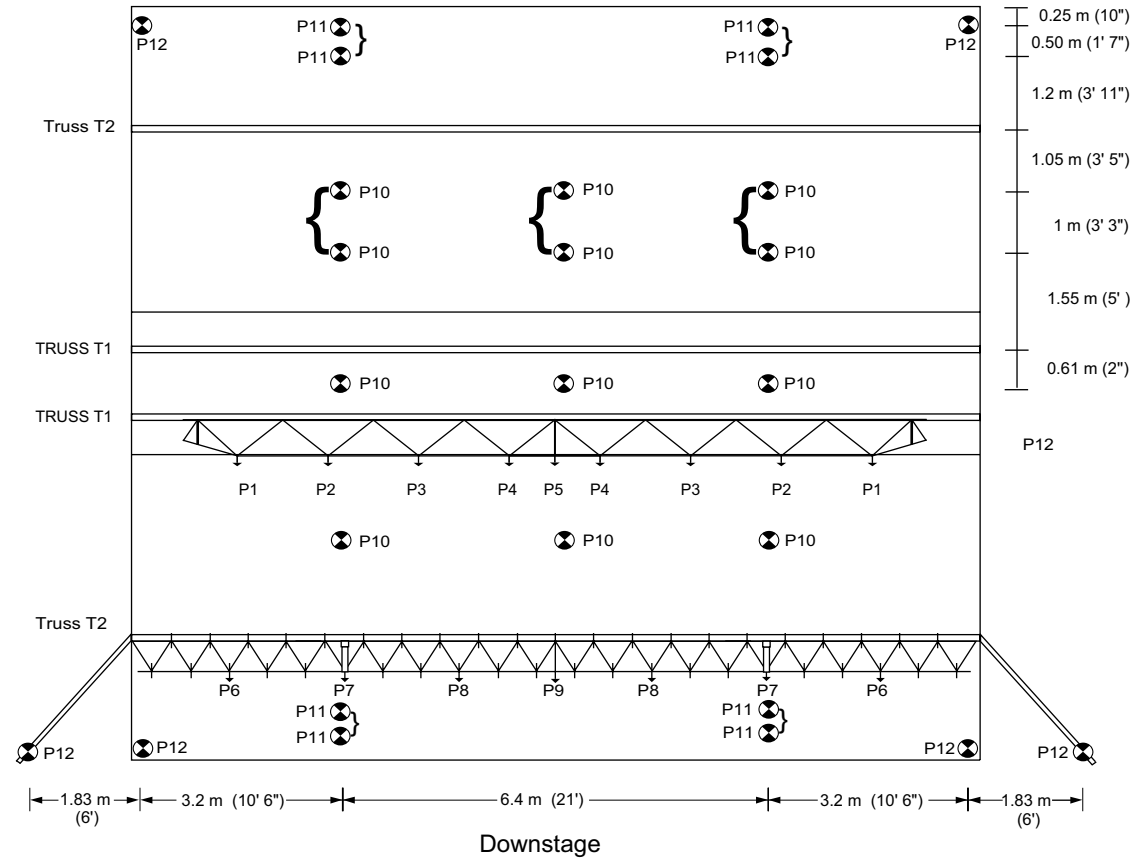

Maximum Load Bearing Capacity - 7247 kg (16000 lbs)

Rigging Plan



700 Marsolais Street
L'Assomption, Quebec
Canada J5W 2G9
Tel: (450) 589-1063
or 1-800-267-8243
Fax: (450) 589-1711
www.stageline.com
info@stageline.com

Stageline SL 320

A thorough understanding of the inter-related loadings shown in this rigging plan is needed in order to safely use this mobile stage roof and to take full advantage of the many rigging opportunities it offers.

This mobile stage roof offers a variety of rigging options with regard to load capacity, placement and type.

There are trusses, rigging pipes, front overhang rigging pipes, side overhang rigging beams, line array rigging beams and roof rigging points.

This rigging plan locates and defines these rigging features, includes load capacity for each and describes maximum combinations of loads amongst features.

Take note of exclusions, maximum sub-totals in a group, load balance requirements, maximum lifting capacity of roof and maximum rigging load on roof.

The maximum load on the roof is less than the sum of the maximum load on each rigging feature.

Maximum Load Bearing Capacity - 7247 kg (16000 lbs)

RIGGING RESTRICTIONS

- Use both P1s, P2s, P3s, P4s or P5 alone.
- Use both P6s, P7s, P8s or P9 alone.
- Do not load more than 454 kg (1000 lbs) on each twin set of P10 in upstage roof panel.
- Do not load more than 227 kg (500 lbs) on each twin set of P11.
- Do not load P11s concurrently with truss T2 or when windwalls are installed.
- Do not load P12s concurrently with P13 to P15.
- Use P14s or P15, never exceeding 1360 kg (3000 lbs).
- Use P13 and P15 or P12 and P14s, never exceeding 1360 kg (3000 lbs).
- P15's rigging capacity reduced to 1360 kg (3000 lbs) when used concurrently with P13.
- If installing banner rigging bars, total load of P12 to P15 must not exceed 1360 kg (3000 lbs).

Notes:

Outside diameter of rigging bars and of lower chord of trusses is 5 cm (2").

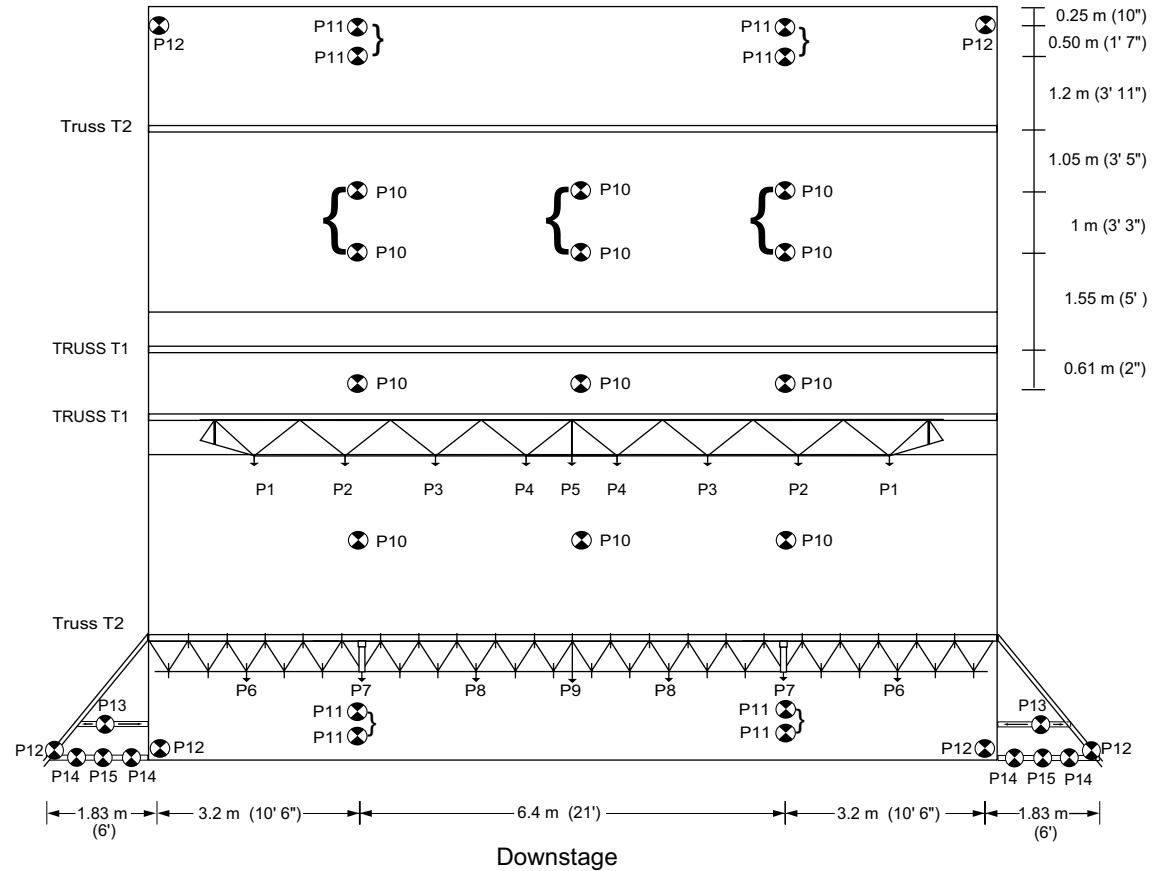

Rigging Point Maximum Load Capacity		
Point No.	Kg	Lbs
P15 (See rigging restrictions)	1814	4000
P12 & P14	908	2000
P1 & P2	680	1500
P3	544	1200
P6, P10 & P13	454	1000
P4 & P5	318	700
P7	295	650
P11	227	500
P8 & P9	182	400

Rigging Plan with Bi-directional Rigging



700 Marsolais Street
 L'Assomption, Quebec
 Canada J5W 2G9
 Tel: (450) 589-1063
 or 1-800-267-8243
 Fax: (450) 589-1711
 www.stageline.com
 info@stageline.com

Stageline SL 320

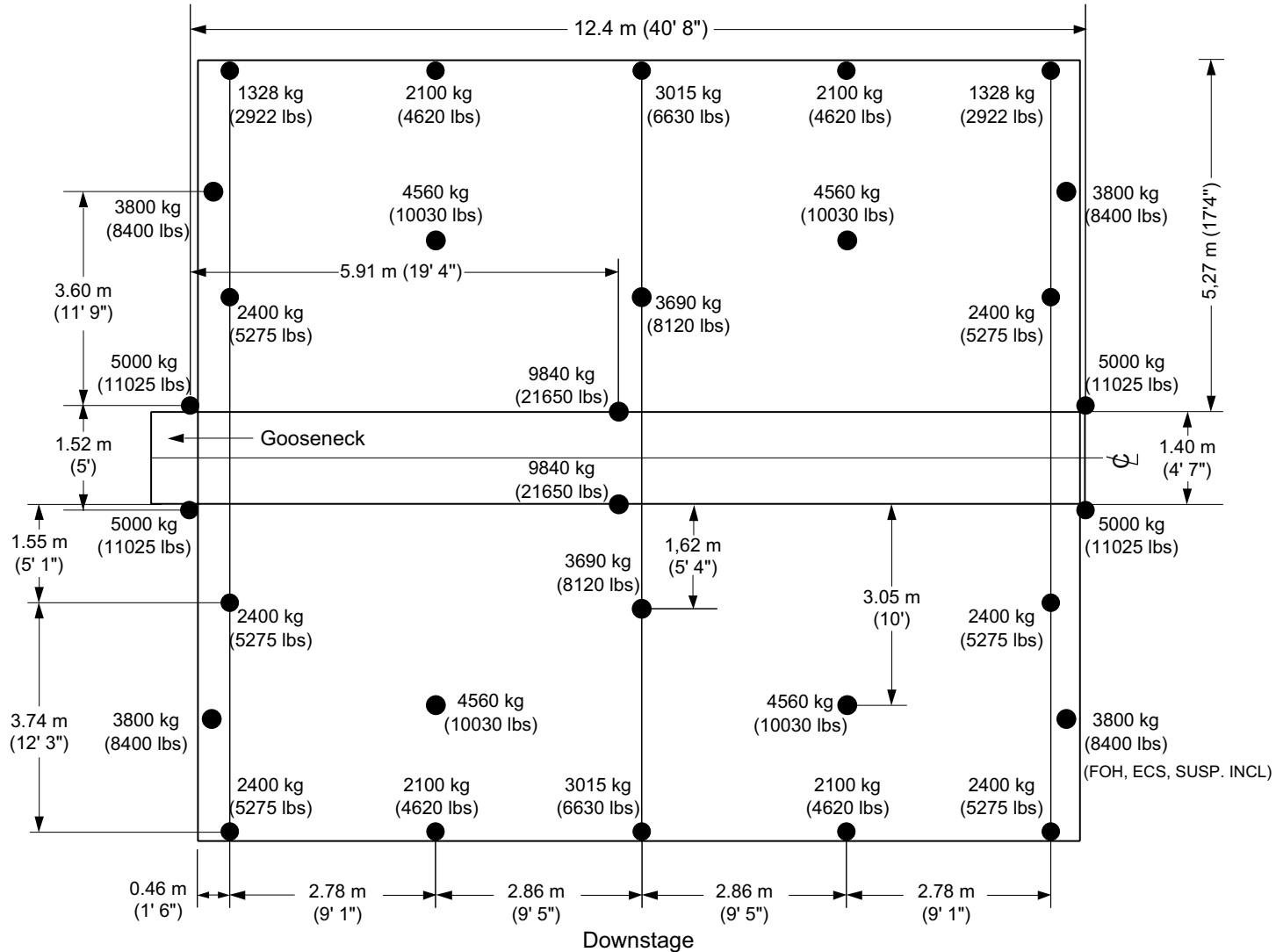

Ground Support Capacity